

SLIDING SINGLE BEND GUIDE

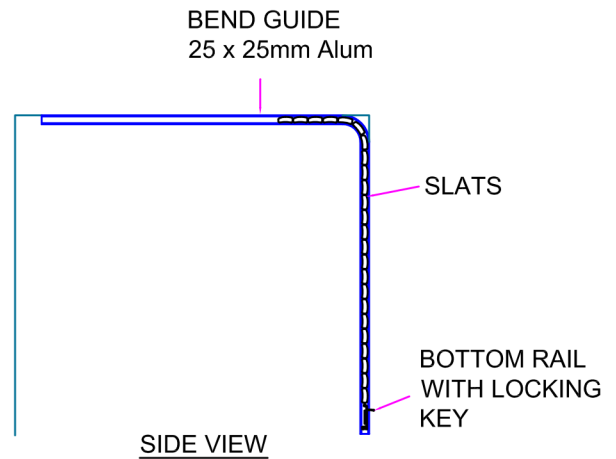

BEND GUIDES CAN BE REPLACED BY NYLON CORNERS

SLIDING DOUBLE BEND GUIDE

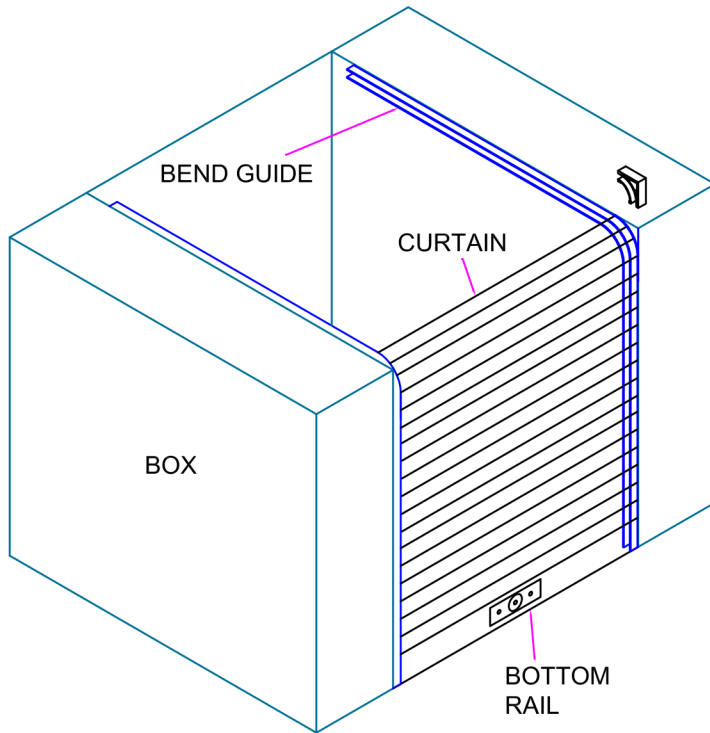
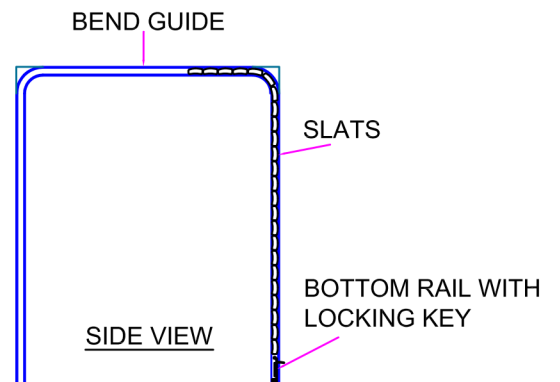
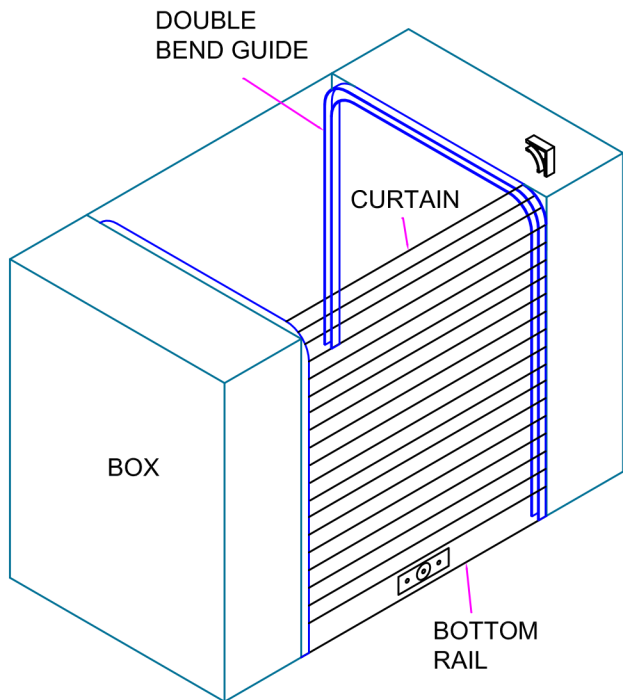

NOTE: OPENING SIZE UP TO 1,500mm x 1,200mm

2EA SLIDING SHUTTER CONFUIRATIONS

CONFIDENTIAL NOTE: This drawing and its designs, specifications and engineering information disclosed hereon are the property of ANSA DOORS and are not to be disseminated or reproduced without express written consent. The drawing is loaned in confidence and then only for consideration of the matter disclosed hereon. In accepting loan of this drawing, the recipient agrees to keep it and the matter disclosed hereon in confidence and not to use nor permit their use in any way detrimental to ANSA DOORS.

SCALE

NTS

DRAWN

H.P.LY

DATE

28/01/11

AUSTRAL MONSOON ENTERPRISES PTY LTD
ATF 'THE ANSA TRUST' TRADING AS
ANSA DOORS

71-73 Maffra Street
Coolaroo Victoria 3048
Australia

Phone: (03) 9302 3366

DWG No:

ANSA-TS0002

P.O Box 201
Dallas, Victoria 3047
Australia

Fax: (03) 9302 3966

ANSA-TS0002